

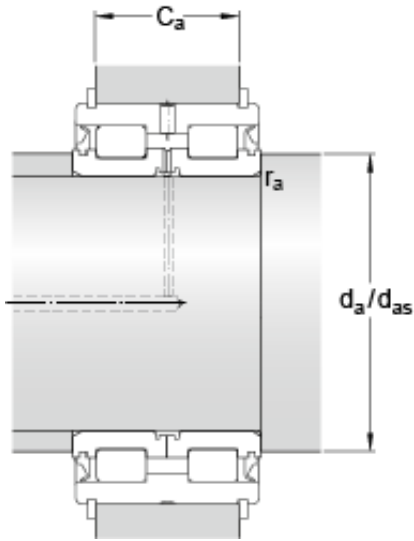

GF BEARING-SINGAPORE LTD.



NNF 5034 B-2LS Bearing 2D drawings and 3D CAD models

170 mm x 260 mm x 122 mm skf NNF 5034 B-2LS Double row full complement cylindrical roller bearings

Bearing No. NNF 5034 B-2LS

d	170 mm
D	260 mm
B	122 mm
C	121 mm
d ₁	203.6 mm
D ₃	254 mm
C ₁	107.2 mm
+	0.2 mm
C ₂	6.9 mm
b	5.2 mm
b ₁	7 mm
K	4 mm
r min.	2 mm
r _{3,4} min.	0.6 mm
d _a min.	177 mm
d _{as}	197 mm
C _{a1}	99 mm
-	0.2 mm
C _{a2}	97 mm
-	0.2 mm
r _a max.	2 mm
Basic dynamic load rating C	1010 kN
Basic static load rating C ₀	1800 kN
Fatigue load limit P _u	193 kN
Limiting speed	480 r/min



GF BEARING-SINGAPORE LTD.

Calculation factor k_r	0.4
Mass bearing	22.5 kg
Snap ring Seeger	SW 260
Snap ring in accordance with DIN 471	260x5