

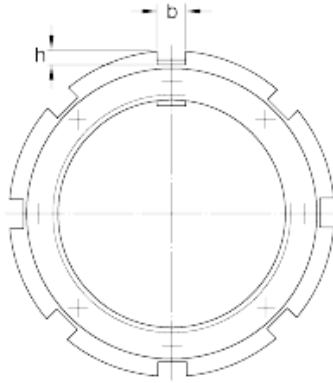

GF BEARING-SINGAPORE LTD.

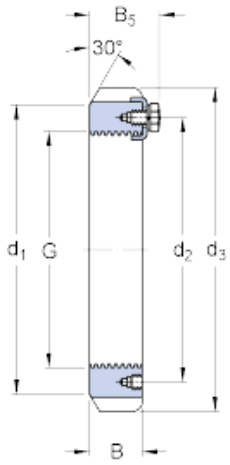

skf HM 31/710 Lock nuts requiring a keyway
(metric)

Bearing No. HM 31/710

G	Tr 710x7
d ₃	900 mm
B	106 mm
d ₁	825 mm
d ₂	772 mm
B ₅	133 mm
b	55 mm
h	30 mm
Mass lock nut	186 kg
Associated spanner	TMFN 600-750
Associated eyebolt for handling	M 16

HM 31/710 Bearing 2D drawings and 3D CAD models