

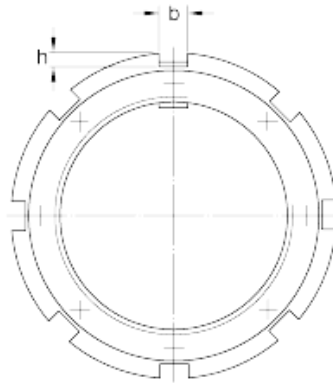

GF BEARING-SINGAPORE LTD.

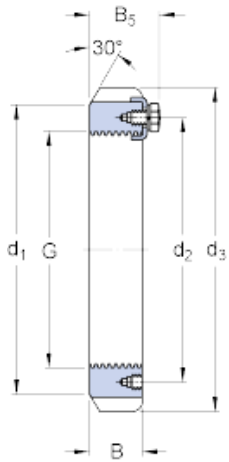

skf HM 30/800 Lock nuts requiring a keyway
(metric)

Bearing No. HM 30/800

G	Tr 800x7
d ₃	920 mm
B	90 mm
d ₁	870 mm
d ₂	832 mm
B ₅	112 mm
b	55 mm
h	25 mm
Mass lock nut	109 kg
Associated spanner	TMFN 600-750
Associated eyebolt for handling	M 12

HM 30/800 Bearing 2D drawings and 3D CAD models