

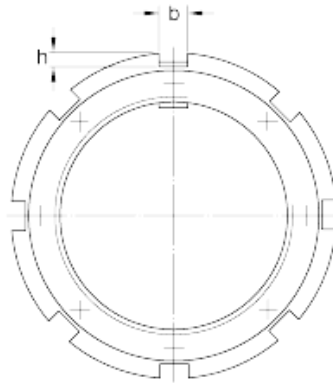

GF BEARING-SINGAPORE LTD.

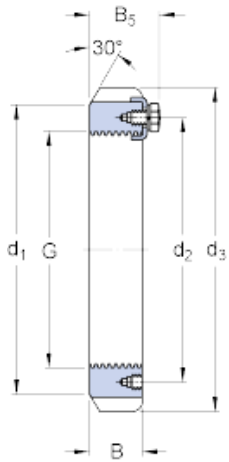

skf HM 30/950 Lock nuts requiring a keyway
(metric)

Bearing No. HM 30/950

G	Tr 950x8
d ₃	1080 mm
B	100 mm
d ₁	1025 mm
d ₂	985 mm
B ₅	125 mm
b	60 mm
h	25 mm
Mass lock nut	156 kg
Associated eyebolt for handling	M 16

HM 30/950 Bearing 2D drawings and 3D CAD models