

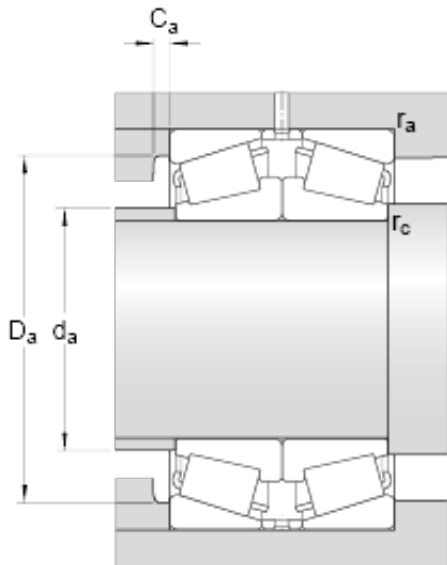

GF BEARING-SINGAPORE LTD.



31314/DF Bearing 2D drawings and 3D CAD models

skf 31314/DF Matched Single row tapered roller bearings arranged face-to-face

Bearing No. 31314/DF

d	70 mm
D	150 mm
T	76 mm
2B	70 mm
b	10 mm
K	7.5 mm
$r_{3,4}$ min.	2.5 mm
r_5 min.	1 mm
d_a max.	85 mm
D_a min.	118 mm
D_a max.	139 mm
C_a min.	5 mm
r_a max.	2.5 mm
r_c max.	1 mm
Basic dynamic load rating C	393 kN
Basic static load rating C_0	440 kN
Fatigue load limit P_u	54 kN
Reference speed	2600 r/min
Limiting speed	4500 r/min
Calculation factor e	0.83
Calculation factor Y_1	0.81
Calculation factor Y_2	1.2
Calculation factor Y_0	0.8
Mass bearing pair	6.1 kg